

MODIFY	DATE	NAME	DRAFTSMAN	Verify by:	Approval	MODEL:	G65/ST-D-001	Ver	D1
A						G65/ST		page	3
B									
C									
D								Tatol Page	8

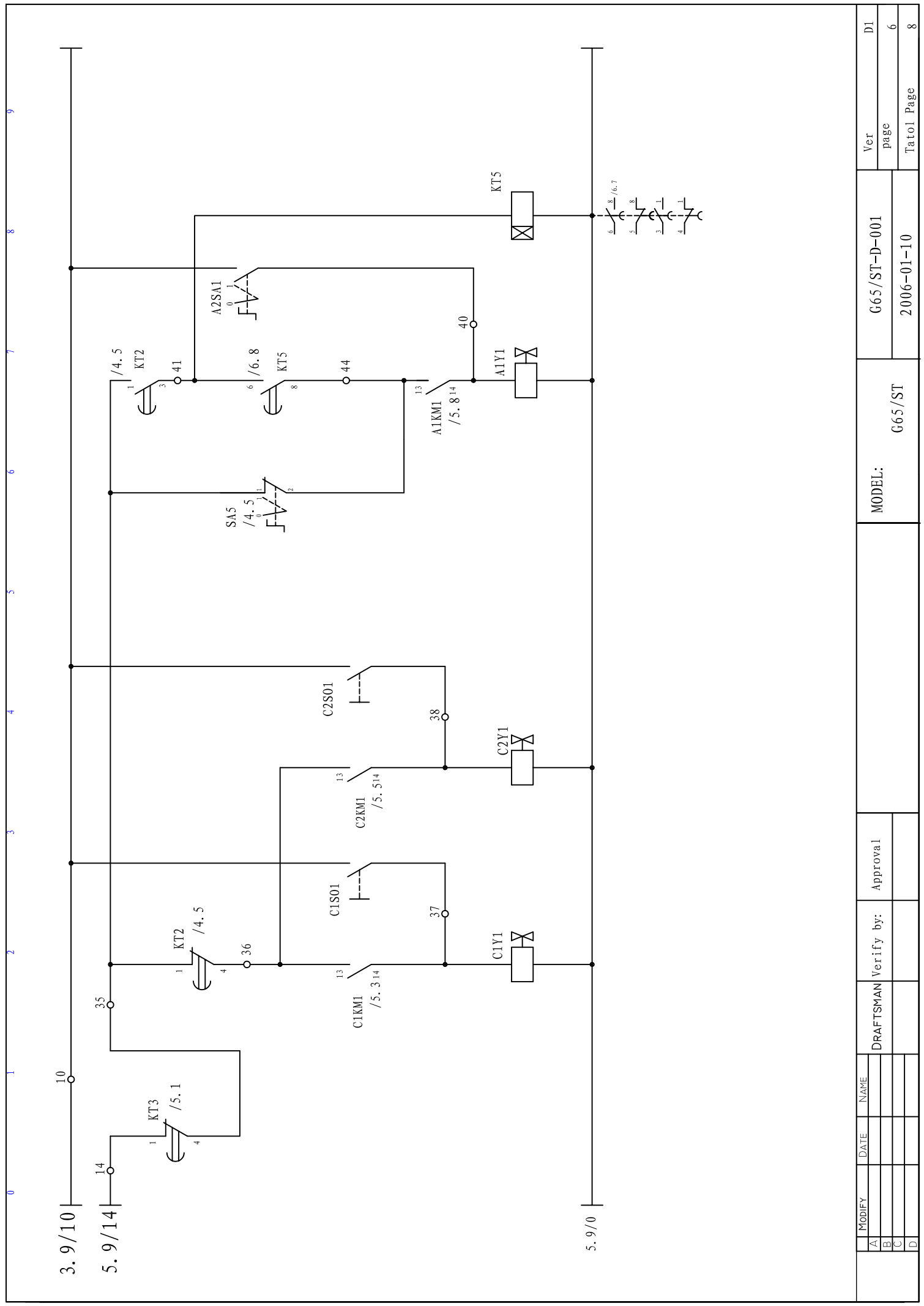

MODIFY	DATE	NAME	DRAFTSMAN	Verify by:	Approval	MODEL:	G65/ST	G65/ST-D-001	Ver page	D1
A									6	
B										
C										
D										
Tatol Page									8	

9

2

1

0

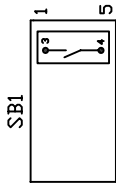
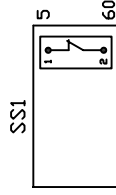
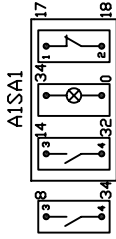
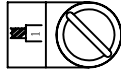
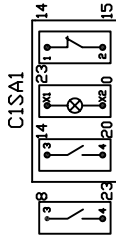
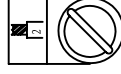
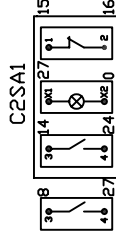
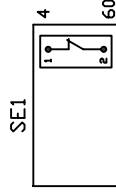
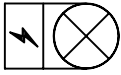
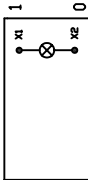
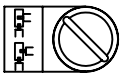
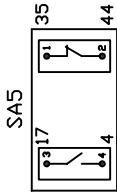
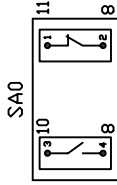
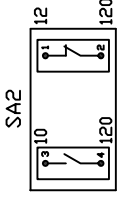
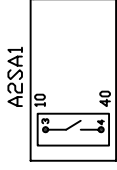

MODIFY	DATE	NAME	DRAFTSMAN	Verify by:	Approval	MODEL: G65/ST	G65/ST-D-001	Ver page 7	D2
A									
B									
C									
D						2006-06-24	Tatol Page 8	8	

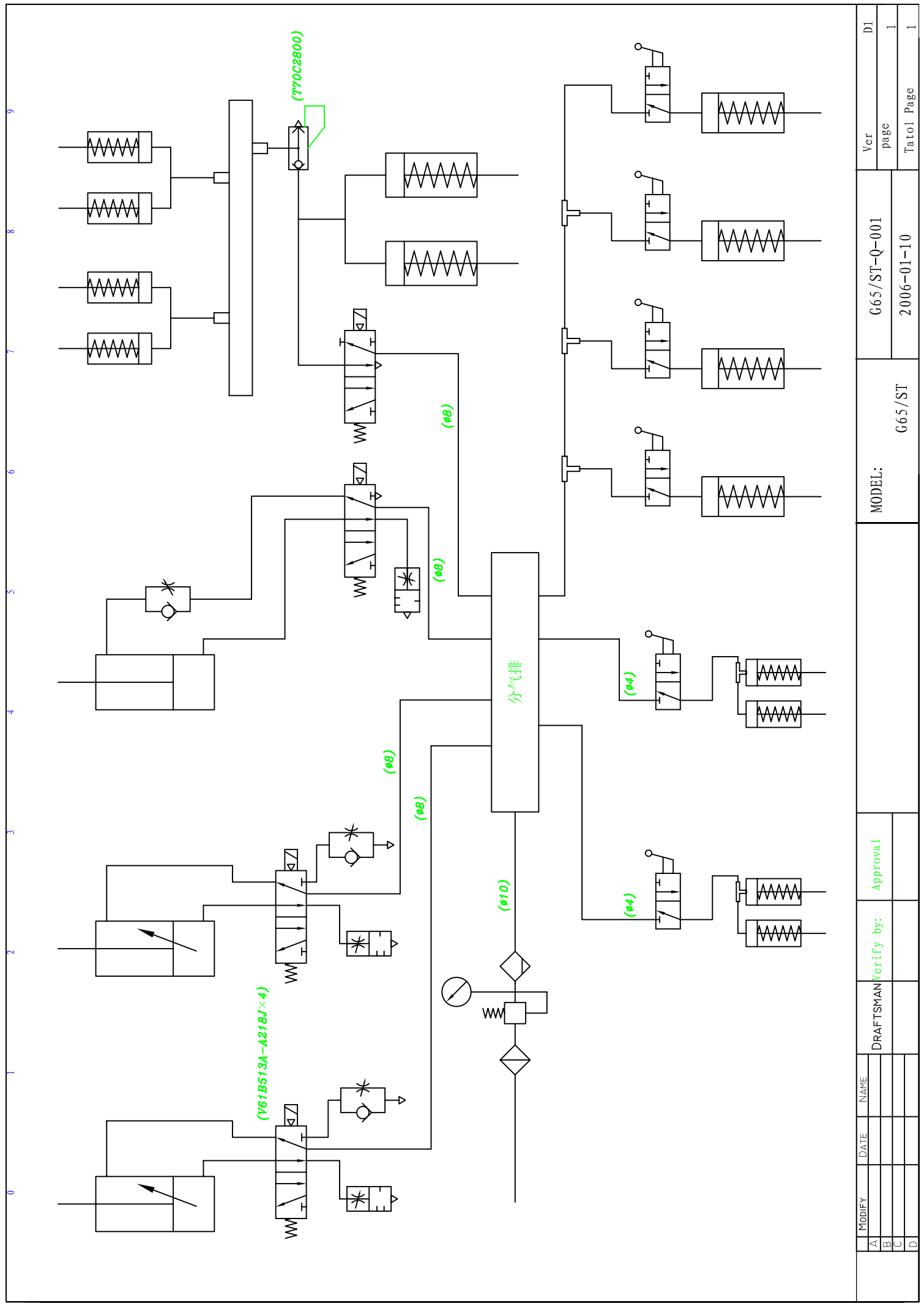

0 1 2 3 4 5 6 7 8 9

MODIFY	DATE	NAME	DRAFTSMAN	Verify by:	Approval	MODEL:	G65/ST-Q-001	Ver	D1
A						G65/ST	2006-01-10	page	1
B									
C									
D									
							Totol Page		1